



Sprint Mobile Broadband 2-in-1 Card
Sierra Wireless AirCard® 402



www.sprint.com

Table of Contents

| | |
|---|-----------|
| <i>Your AirCard 402 Device</i> | <i>i</i> |
| <i>How to Use This Guide</i> | <i>ii</i> |
| Section 1: Introducing the AirCard 402 Device | 1 |
| 1A. Introducing the AirCard 402 Device | 2 |
| Your AirCard 402 Device | 2 |
| TRU-Install | 2 |
| Package Contents | 3 |
| Care and Maintenance | 3 |
| Section 2: Setting Up and Using the AirCard 402 Device | 5 |
| 2A. Setting Up Your Sprint Account | 6 |
| Setting Up Your Device on Your Sprint Account | 6 |
| 2B. Installing the Software and Activating Your Device | 7 |
| Installing the Software on a Windows Computer | 7 |
| Installing the Software on a Mac Computer | 13 |
| Activating Your AirCard 402 Device | 16 |
| 2C. Using Your AirCard 402 Device | 17 |
| Starting the Windows Software | 17 |
| Starting the Mac Software | 18 |
| Viewing the User Guide | 18 |
| Removing the AirCard 402 Device | 19 |
| Attaching an External Antenna | 20 |
| Contacting Sprint Customer Service | 20 |
| Troubleshooting | 21 |

| | |
|---|-----------|
| Section 3: Technical Specifications, Regulatory and Safety Information, and Warranty | 23 |
| 3A. Technical Specifications | 24 |
| LED Operation | 24 |
| Radio Frequency and Electrical Specifications | 26 |
| Software Specifications | 27 |
| Environmental Specifications | 28 |
| 3B. Regulatory Information | 29 |
| Regulatory Notices | 29 |
| Patents | 33 |
| Trademarks | 33 |
| Copyright | 34 |
| Limitation of Liability | 34 |
| Additional Information and Updates | 34 |
| 3C. Important Safety Information | 35 |
| Important Notice | 35 |
| Safety and Hazards | 35 |
| 3D. One-Year Limited Warranty | 37 |

Your AirCard 402 Device

Thank you for purchasing a Sierra Wireless AirCard 402 device. This device offers more freedom than ever before. No wires, no cables—just access to your data when you need it. The power of the Internet is truly at your fingertips.



How to Use This Guide

The advantages of Sprint are as clear as each wireless connection you make. With Sprint service, we give you what you really want from a wireless service provider—clear connections, easy-to-understand service plans, and self-servicing options for managing your account. All this is designed to make your life easier and worry-free.

We know you're eager to start using your device right away, and the sections of this guide are designed to help you do just that.

- 1** The first section (page 1) gives an overview of the AirCard 402 package contents.
- 2** The second section (page 5) guides you through the steps required to install your AirCard 402 device and the Windows or Mac software, and describes how to start the software once it is installed.
- 3** The third section (page 23) lists the technical specifications, regulatory and important safety information, and warranty information for your AirCard 402 device.

Getting More Information About Your Device and Service

This guide describes how to install and start the software. To learn how to use all the features of your device and software, consult the user guide (see page 18 of this document) or online help.

Section 1

***Introducing the
AirCard 402 Device***



Introducing the AirCard 402 Device

- ◆ *Your AirCard 402 Device (page 2)*
- ◆ *TRU-Install (page 2)*
- ◆ *Package Contents (page 3)*
- ◆ *Care and Maintenance (page 3)*

This section introduces your AirCard 402 device, and describes what is included with your device.

Your AirCard 402 Device

The Sierra Wireless AirCard 402 device is a dual-band wireless modem. It enhances the functionality of your mobile computing devices by adding wireless connectivity to the Internet.

Your AirCard 402 device fits into a PC Card or ExpressCard slot (available on most notebook and some desktop computers).

TRU-Install

To install the drivers and software, you do not need an installation CD. Your device uses the Sierra Wireless TRU-Install™ feature—driver and software installation starts when you insert the device into your Windows or Mac computer.

Note

To get the latest drivers and software, visit www.sprint.com/downloads.

Package Contents

Your AirCard 402 device package contains the following components:

- Sierra Wireless AirCard 402 device
- Get Started guide (this document)

Care and Maintenance

As with any electronic device, you should handle this device with care to ensure reliable operation. Follow these guidelines in using and storing the device:

- Do not apply adhesive labels to the device or the card adapter, as they may cause the device or the card adapter to become jammed inside the card slot.
- The device should fit easily into an available PC Card or ExpressCard slot. Forcing the device into a slot may damage the connector pins.
- Protect the device from liquids, dust, and excessive heat.
- When not installed in your computer, store the device in its protective case.
- Remove the device before storing or transporting your computer.
- When inserting or removing the device, always grip it by the sides rather than the top, as this prevents damage to the device.
- Do not use the device with a handheld computer; it is designed only for notebook or desktop computers running Windows Vista, Windows XP, Windows 2000, Mac OS X, or Linux.
- Do not handle or operate the device while driving or operating a vehicle. Doing so may distract you from properly operating the vehicle. In some jurisdictions, operating communication devices while in control of a vehicle is a criminal offense.

Section 2

***Setting Up and Using the
AirCard 402 Device***



Setting Up Your Sprint Account

- ◆ *Setting Up Your Device on Your Sprint Account (page 6)*

Setting Up Your Device on Your Sprint Account

Normally your device will be set up on your Sprint account at the time of purchase.

To verify that your device is set up on your Sprint account:

1. Log on to your account at www.sprint.com by entering your username and password.
2. Confirm that the AirCard 402 device is on your account with a Mobile Broadband connection plan.

If you don't see your device listed, you will need to contact Sprint Customer Service to complete setting up the device on your account. Have the following available before calling:

- Your Sprint account information.
- The ESN number of your device (displayed on the back of the device and on the packaging).

Section 2B

Installing the Software and Activating Your Device

- ♦ *Installing the Software on a Windows Computer (page 7)*
- ♦ *Installing the Software on a Mac Computer (page 13)*
- ♦ *Activating Your AirCard 402 Device (page 16)*

The installation process has two stages:

- **Installing the Software and Drivers** — Insert the device to install the drivers and the software (for Windows, see below; for Mac, see page 13).
- **Activating Your Device** — Start the software. Sprint's hands-free activation feature will automatically begin activating your device on the network (page 16).

For information on using the AirCard 402 device on Linux, please see www.sierrawireless.com/support.

Installing the Software on a Windows Computer

System Requirements

The AirCard 402 device works with:

- Windows Vista.
- Windows XP with Service Pack 2 or later.
- Windows 2000 with Service Pack 4.

Note *Your device will not work with handhelds or Pocket PCs.*

To install and run the device and accompanying Sprint SmartViewSM software on a Windows computer, you will need an empty PC Card or ExpressCard slot.

Installing the Software and Drivers

Note *Windows Vista and Windows 2000 users: You must log in with administrative privileges to install the software and drivers.*

Windows XP users: You may need to log in with administrative privileges, depending on your Windows configuration.

As part of the installation process you may need to restart your computer; save any open documents.

1. Ensure you are in the Sprint Mobile Broadband coverage area (not roaming).
2. If your computer has WiFi or a Bluetooth adapter, turn it off. (For instructions, see the user guide or online Help of your computer.)

3. If your computer has a PC Card slot, grip both sides of the card adapter and insert the device and card adapter into your computer (Sprint label facing up), and then proceed to “Windows detects the device...” on page 11.

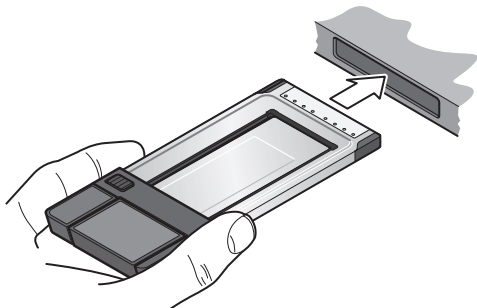

If your computer has an ExpressCard slot, remove the device from the card adapter, as described below.

4. Slide and hold the locking tab in the indicated direction.

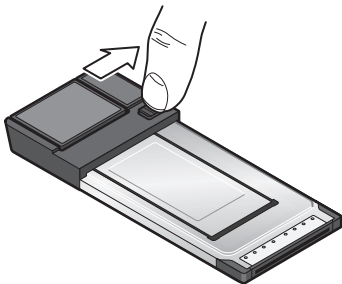

5. Holding the locking tab, use your other hand to free the device from the adapter.

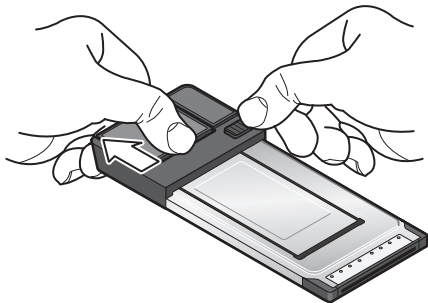

6. Gripping both sides of the device, insert it into your computer's ExpressCard slot (Sprint label facing up).

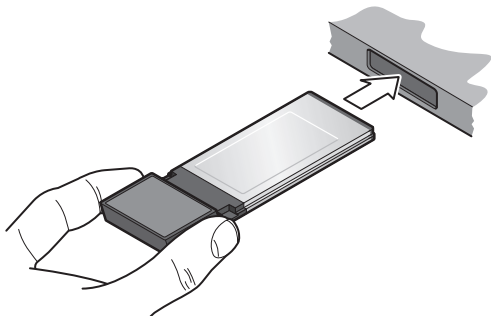

Windows detects the device and installs the drivers for it. This may take a few minutes. Once completed, the system tray may display “Your devices are ready to use” or “Your new hardware is installed and ready to use.”

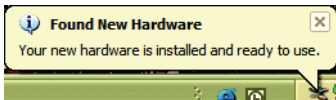

The  LED indicator is lit (blue, or blinking amber); the Sprint logo on the protruding end of the device is also lit.

7. If the TRU-Install window is not displayed, in Windows Explorer browse to the  TRU-Install entry (under *My Computer*), then browse to the *Win* folder and run *Setup.exe* or, if you're running Windows Vista and the "AutoPlay" window is displayed, click *Run setup.exe* to display the TRU-Install window.
8. In the TRU-Install window, click *OK*.



9. In the “WinZip Self-Extractor” window, click *Setup*.
10. In the “Welcome to the InstallShield Wizard for Sprint SmartView” window, click *Next*.

11. Read the License Agreement, select “**I accept the terms in the License Agreement**” to agree to the terms and then click **Next**.
12. In the “Installation Customization Wizard” window, select a skin and then click **Next**. (A series of dialog boxes guides you through the installation.)
13. Use the **Next** and **Back** buttons to navigate through the wizard.
14. If you’re running Windows Vista or Windows XP, wait until the system tray displays “Your devices are ready to use” or “Your new hardware is installed and ready to use.”

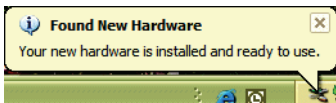

15. In the “InstallShield Wizard Completed” window, click **Finish**.
16. If you see a message that you must restart your computer, click **Yes** and wait until your computer restarts.
17. If the Sprint SmartView software has not started, start it by double-clicking the program’s icon  on your desktop.
18. Proceed to “Activating Your AirCard 402 Device” on page 16.

Installing the Software on a Mac Computer

System Requirements

The AirCard 402 device works with any MacBook™ Pro or PowerBook® G4 computer running Mac OS X version 10.4.11 or newer.

To check your version, from the Apple menu () choose **About This Mac**. If your version is earlier than 10.4.11, then you must upgrade to version 10.4.11 or newer; contact an Apple reseller, an Apple retail store, or visit www.apple.com/store.

To install and run the device and accompanying Sprint SmartView software on a Mac computer, you will need an empty PC Card or ExpressCard slot.

Installing the Software and Drivers

Note

As part of the installation process you will need to restart your computer; save any open documents.

1. Ensure you are in the Sprint Mobile Broadband coverage area (not roaming).
2. If your computer has an AirPort®, AirPort Extreme®, AirPort Express®, or Bluetooth adapter, turn it off. (For instructions, see your computer's user guide.)

3. If your computer has a PC Card slot, grip both sides of the card adapter and insert the device and card adapter into your computer (Sprint label facing up), and then proceed to step 7 on page 15.

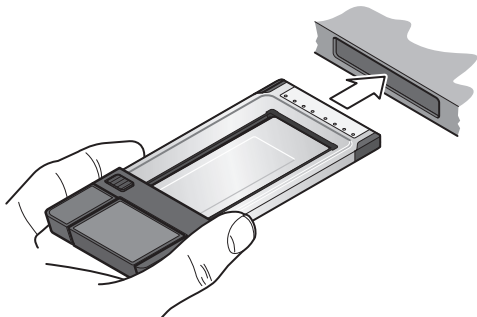

If your computer has an ExpressCard slot, remove the device from the card adapter, as described below.

4. Slide and hold the locking tab in the indicated direction.

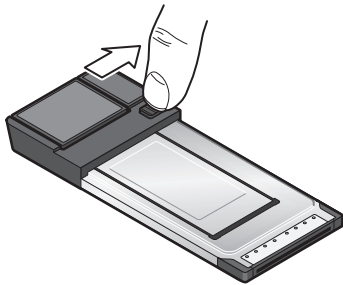

5. Holding the locking tab, use your other hand to free the device from the adapter.

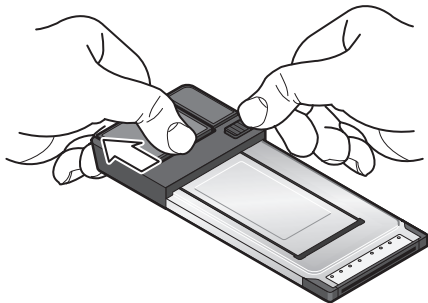

6. Gripping both sides of the device, insert it into your computer's ExpressCard slot (Sprint label facing up).

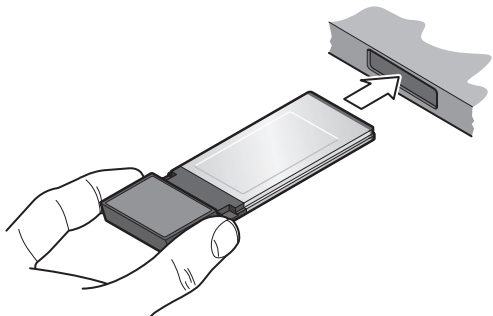

7. In the "TRU-Install" window, double-click *Install Sprint SmartView.mpkg*.

8. In the “This package contains a program...” window, click **Continue**.
9. In the “Welcome to the Sprint SmartView Installer” window, click **Continue**.
10. Read the Software License Agreement. To continue with the software installation, you must click **Continue**, and then click **Agree** to accept the terms.
11. In the “Standard Install on ...” window, click **Install**.
12. If a window appears prompting you for your password, enter your Mac password and then click **OK**.
13. In the window with the message that you will have to restart your computer, click **Continue Installation**.
14. In the “Please Choose a Skin” window, click one of the two images and then click **Continue**.
15. In the “Install Succeeded” window, click **Restart**.
16. After your computer restarts, start the Sprint SmartView software by double-clicking the program’s icon [] on your Mac desktop.

Activating Your AirCard 402 Device

After you have successfully installed Sprint SmartView and while your device is connected to your computer, Sprint SmartView will inform you that hands-free activation has started and will periodically give you updates about activation status. No intervention is required on your part.

If activation is successful, Sprint SmartView will display “Hands Free Activation Complete,” after which you are ready to connect to the network.

Using Your AirCard 402 Device

- ◆ *Starting the Windows Software (page 17)*
- ◆ *Starting the Mac Software (page 18)*
- ◆ *Viewing the User Guide (page 18)*
- ◆ *Removing the AirCard 402 Device (page 19)*
- ◆ *Attaching an External Antenna (page 20)*
- ◆ *Contacting Sprint Customer Service (page 20)*
- ◆ *Troubleshooting (page 21)*

Starting the Windows Software

- ▶ Double-click the program's icon [] on your desktop.
 - or –
 - In Windows Vista, select **Start > All Programs > Sprint > SmartView > Sprint SmartView**.
 - or –
 - In Windows XP or Windows 2000, select **Start > Programs > Sprint > SmartView > Sprint SmartView**.

Proceed to “Viewing the User Guide” on page 18.

Starting the Mac Software

If the Sprint SmartView software has not started automatically:

- ▶ Double-click the program's icon [] on your Mac desktop.
 - or –
- In Finder™, select *Go > Applications > Sprint SmartView*, and then double-click *Sprint SmartView*.

Viewing the User Guide

The user guide provides detailed information on the Windows and Mac versions of the Sprint SmartView software.

- ▶ In Windows Vista, select *Start > All Programs > Sprint > SmartView > Users Guide*.
 - or –
- ▶ In Windows XP or Windows 2000, select *Start > Programs > Sprint > SmartView > Users Guide*.
 - or –
- ▶ On your Mac, in Finder select *Go > Applications > Sprint SmartView*, and then double-click *Sprint SmartView_User_Guide.PDF*.

Removing the AirCard 402 Device

1. Exit the Sprint SmartView software if it is open.
2. If you're running Windows 2000, click the Unplug or Eject Hardware icon  in the system tray, and click the entry for *NEC PCI to USB Open Host Controller* or *Standard Enhanced PCI to USB Host Controller*. If a dialog box appears notifying you that it is safe to remove the device, click **OK**.
3. If your computer has a PC Card or ExpressCard ejector, use it to eject the device from the slot.
4. Remove the device from your computer's PC Card or ExpressCard slot by gripping both sides of the device and pulling straight out.

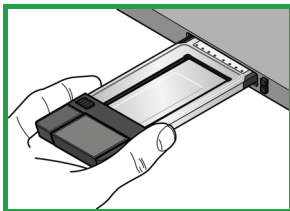

Correct

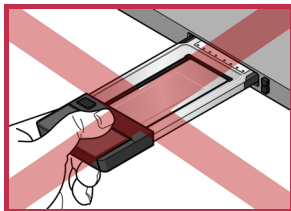

Incorrect

WARNING

When inserting or removing your device, always grip it by its sides, as this prevents damage to the device.

Attaching an External Antenna

You can improve the signal strength by attaching an external antenna with a TS9 connector (sold separately). The recommended antenna is the 6-band blade antenna with TS9 connector, available from www.sierrawireless.com (part number 6000342).

CAUTION Use of other antennas may violate FCC requirements.

1. If the device is connected to your computer, remove it.
2. Gently flip open the tab on the side of the device.
3. Hold the antenna cable by the connector (end) part, and carefully insert the connector part of the cable into the corresponding connector on the device.
4. Reinsert the device into your computer.



Contacting Sprint Customer Service

You can reach Sprint Customer Service by:

- Logging on to your account at www.sprint.com.
- Calling us toll-free at **1-888-211-4727** (personal use) or **1-800-927-2199** (business use).
- Writing to us at Sprint Customer Service, P.O. Box 8077, London, KY 40742.

Troubleshooting

For a more complete listing of errors and possible solutions, please see the user guide or online Help. You may also visit www.sprint.com or contact Sprint Customer Service (see above).

| <i>Problem/error</i> | <i>Solution</i> |
|---|--|
| The device has no power. (The  LED indicator is off.) | Ensure the following: <ul style="list-style-type: none">● The device is properly inserted.● The computer is turned on and not in suspend mode (Windows) or sleep mode (Mac). |
| No service is available. (The  LED indicator is off.) | Try the following: <ul style="list-style-type: none">● Reorient your computer.● If you are inside a building or near a structure that may be blocking the signal, change the position or location of your computer.● Check with Sprint — a network or account problem may be preventing the device from obtaining service. |

Section 3

***Technical Specifications,
Regulatory and Safety Information,
and Warranty***



Technical Specifications

- ◆ *LED Operation (page 24)*
- ◆ *Radio Frequency and Electrical Specifications (page 26)*
- ◆ *Software Specifications (page 27)*
- ◆ *Environmental Specifications (page 28)*

This section describes the LED indicators and various specifications of your AirCard 402 device.

LED Operation

Your device has two LED indicators. They operate as follows:

| <i>LED</i> | <i>State of LED</i> | <i>Indicates</i> |
|---|---------------------|---|
|  | Off | The device has no power. The device may not be completely inserted into the computer; the computer may be turned off; or it may be in suspend mode (Windows) or sleep mode (Mac), causing the device to shut down; or you may have disabled the device (through the Sprint SmartView software). |
| | Blue, not blinking | The device has power and is working properly. |
| | Blue, blinking | The firmware is updating. Do not remove the device. |

| <i>LED</i> | <i>State of LED</i> | <i>Indicates</i> |
|------------|---------------------|---|
| | Amber, blinking | The device is searching for service. If this state persists, try the following: <ul style="list-style-type: none"> ● Reorient your computer. ● If you are inside a building or near a structure that may be blocking the signal, change the position or location of your computer. ● Check with Sprint — a network or account problem may be preventing the device from obtaining service. |
| | Amber, not blinking | An error has occurred. Remove the device and reinsert it. |
| ⇕ | Off | No service is available. If this state persists, try the following: <ul style="list-style-type: none"> ● Try reorienting your computer. ● If you are inside a building or near a structure that may be blocking the signal, change the position or location of your computer. ● Check with Sprint — a network or account problem may be preventing the device from obtaining service. |
| | Amber, blinking | 1xRTT coverage is detected. Ready to connect to the network; see the user guide. |
| | Amber, not blinking | The device is connected to a 1xRTT network and can send or receive data. |
| | Blue, blinking | 1xEV-DO coverage is detected. Ready to connect to the network; see the user guide. |
| | Blue, not blinking | The device is connected to a 1xEV-DO network and can send or receive data. |

Radio Frequency and Electrical Specifications

| | |
|---------------------|---|
| Approvals | Compliant with: IS-2000 Release 1.0 (CDMA (1X)), IS-707-A Data, IS-856 (CDMA 1xEV-DO), IS-866, IS-878, IS-890, CDMA Development Group FCC Industry Canada |
| Voltage | +3.3 Vdc from PC Card or ExpressCard slot |
| Current | Maximum: 1300 mA Typical data call current (talk mode): 350 mA (1X) 430 mA (1xEV-DO) Standby: 100 mA (1xEV-DO/IS-2000 hybrid mode) |
| Transmitter power | 250 mW (24 dBm) average |
| Transmit | PCS: 1850 to 1909.95 MHz Cellular: 824.04 to 848.97 MHz |
| Receive | PCS: 1930 to 1989.95 MHz Cellular: 869.04 to 893.97 MHz GPS: 1575.42 MHz |
| Channel spacing | 1.25 MHz |
| Frequency stability | ± 150 Hz |

Software Specifications

| | |
|-----------------------------------|----------------------|
| Position Location | Mobile Station based |
| Data service | IS-707A |
| Mobile IP | Supported |
| SMS (IS-637) | Not supported |
| FAX | Not supported |
| OMA-DM | Supported |
| OTASP (IS-683A, IS-683B, IS-683C) | Not supported |
| OTAPA | Not supported |
| PRL (preferred roaming list) | Supported |
| Authentication | Supported |
| NAM | Single |
| Voice | Not supported |
| E911 | Not supported |
| TTY/Accessibility | Not supported |

Environmental Specifications

| | |
|-----------------------|---|
| Operating temperature | -4 to +131°F (ambient, outside PCMCIA/ExpressCard enclosure) |
| Storage temperature | -40 to +185°F |
| Humidity | 95%, non-condensing |
| Vibration | Random vibration, 10 to 1000 Hz, nominal 6G RMS in each of 3 mutually perpendicular axes. Test duration of 60 minutes for each axis, for a total test time of 3 hours (non-operating). |
| Drop | 1 m on concrete on each of 6 faces, 2 times |

Regulatory Information

- ◆ *Regulatory Notices (page 29)*
- ◆ *Patents (page 33)*
- ◆ *Trademarks (page 33)*
- ◆ *Copyright (page 34)*
- ◆ *Limitation of Liability (page 34)*
- ◆ *Additional Information and Updates (page 34)*

This section contains important regulatory notices about your AirCard 402 device, and also patent and other information.

Regulatory Notices

The design of the AirCard 402 device complies with U.S. Federal Communications Commission (FCC) and Industry Canada (IC) guidelines respecting safety levels of radio frequency (RF) exposure for portable devices, which in turn are consistent with the following safety standards previously set by Canadian, U.S. and international standards bodies:

- ANSI / IEEE C95.1-1999, *IEEE Standard for Safety Levels with Respect to Human Exposure to Radio Frequency Electromagnetic Fields, 3kHz to 300 GHz*
- National Council on Radiation Protection and Measurements (NCRP) Report 86, 1986, *Biological Effects and Exposure Criteria for Radio Frequency Electromagnetic Fields*
- Health Canada, Safety Code 6, 1999, *Limits of Human Exposure to Radio frequency Electromagnetic Fields in the Frequency Range from 3 kHz to 300 GHz*

- International Commission on Non-Ionising Radiation Protection (ICNIRP) 1998, *Guidelines for limiting exposure to time-varying electric, magnetic, and electromagnetic fields (up to 300 GHz)*

FCC ID: N7NAC402

CAUTION: The AirCard 402 device must be 1.2 cm or more from users during operation, to satisfy FCC RF exposure requirements. It is recommended to use the AirCard 402 device in a PC Card slot whenever possible. If the laptop computer has two slots, it is recommended to use the upper slot for optimum modem performance. When the AirCard 402 device is inserted into the laptop computer during lap held usage, it is recommended that the antenna portion of the AirCard 402 device be moved away from the leg to ensure the maximum data rate is available to the user. The AirCard 402 device has been tested for compliance with FCC / IC RF exposure limits in the laptop computer(s) configurations with the side loading PC Card or ExpressCard slot and can be used in laptop computers with substantially similar physical dimensions, construction, and electrical and RF characteristics. This device must not be used with any other antenna or transmitter that has not been approved to operate in conjunction with this device. **NOTE:** This device must not be used in any unapproved configurations. For details, contact Sierra Wireless.

Use of this device in any other configuration may exceed the FCC RF Exposure compliance limit. **NOTE:** If this device is intended for use in any other portable device, you are responsible for separate approval to satisfy the SAR requirements of Part 2.1093 of FCC rules.

WARNING (EMI) - United States FCC Information - This equipment has been tested and found to comply with the limits for a Class B computing device peripheral, pursuant to Part 15 of the FCC rules. These limits are designed to provide reasonable protection against harmful interference in a residential installation.

This equipment generates, uses, and can radiate radio frequency energy and, if not installed and used in accordance with the instructions, may cause harmful interference to radio communications. However, there is no guarantee that interference will not occur in a particular installation.

If this equipment does cause harmful interference to radio or television reception, which can be determined by turning the equipment off and on, the user is encouraged to try to correct the interference by one or more of the following measures:

- Reorient or relocate the receiving antenna.
- Increase the separation between the equipment and receiver.
- Connect the equipment into an outlet on a circuit different from that to which the receiver is connected.
- Consult the dealer or an experienced radio/TV technician for help.

This device complies with Part 15 of the FCC Rules. Operation is subject to the condition that this device does not cause harmful interference.

CAUTION: Any changes or modifications not expressly approved by Sierra Wireless could void the user's authority to operate the equipment.

WARNING (EMI) - Canada: This digital apparatus does not exceed the Class B limits for radio noise emissions from digital apparatus as set out in the interference causing equipment standard entitled "Digital Apparatus," ICES-003 of the Department of Communications.

Cet appareil numérique respecte les limites de bruits radioélectriques applicables aux appareils numériques de Classe B prescrites dans la norme sur le matériel brouilleur: "Appareils Numériques," NMB-003 édictée par le ministre des Communications.

If you have purchased this product under a United States Government contract, it shall be subject to restrictions as set forth in subparagraph (c)(1)(ii) of Defense Federal Acquisitions Regulations (DFARs) Section 252.227-7013 for Department of Defense contracts, and as set forth in Federal Acquisitions Regulations (FARs) Section 52.227-19 for civilian agency contracts or any successor regulations. If further government regulations apply, it is your responsibility to ensure compliance with such regulations.

Information pertaining to OEM customers

The AirCard 402 device has been granted modular approval for mobile applications. Integrators may use the AirCard 402 device in their final products without additional FCC/IC certification if they meet the following conditions. Otherwise, additional FCC/IC approvals must be obtained.

1. At least 20 cm separation distance between the antenna and the user's body must be maintained at all times.
2. To comply with FCC/IC regulations limiting both maximum RF output power and human exposure to RF radiation, the maximum antenna gain must not exceed 2.0 dBi in the Cellular band and 2.96 dBi in the PCS band.
3. The AirCard 402 device and its antenna must not be colocated with any other transmitter or antenna within a host device.
4. A label must be affixed to the outside of the end product into which the AirCard 402 device is embedded, with a statement similar to the following:
This device contains FCC ID: N7NAC402.
This equipment contains equipment certified under IC: 2417C-AC402.
5. A user manual with the end product must clearly indicate the operating requirements and conditions that must be observed to ensure compliance with current FCC/IC RF exposure guidelines.
6. The end product with an embedded AirCard 402 device must pass the unintentional emission testing and properly authorized per FCC Part 15 requirements.

Note

If this device is intended for use in a portable device, you are responsible for separate approval to satisfy the SAR requirements of FCC Part 2.1093 and IC RSS-102.

Patents

Portions of this product are covered by some or all of the following US patents:

| | | | | | | |
|-----------|-----------|-----------|-----------|-----------|-----------|-----------|
| 5,515,013 | 5,629,960 | 5,845,216 | 5,847,553 | 5,878,234 | 5,890,057 | 5,929,815 |
| 6,169,884 | 6,191,741 | 6,199,168 | 6,339,405 | 6,359,591 | 6,400,336 | 6,516,204 |
| 6,561,851 | 6,643,501 | 6,653,979 | 6,697,030 | 6,785,830 | 6,845,249 | 6,847,830 |
| 6,876,697 | 6,879,585 | 6,886,049 | 6,968,171 | 6,985,757 | 7,023,878 | 7,053,843 |
| 7,106,569 | 7,145,267 | 7,200,512 | 7,287,162 | 7,295,171 | D442,170 | D459,303 |
| D559,256 | D560,911 | | | | | |

and other patents pending.

This product includes technology licensed from QUALCOMM® 3G.

Manufactured or sold by Sierra Wireless or its licensees under one or more patents licensed from InterDigital Group.

Trademarks

Sprint and the logo are trademarks of Sprint. Other marks are the property of their respective owners.

Sierra Wireless, the Sierra Wireless logo, TRU-Install, and the red wave design are trademarks of Sierra Wireless.

Windows® is a registered trademark of Microsoft Corporation.

Mac OS is a trademark of Apple Inc., registered in the U.S. and other countries.

QUALCOMM® is a registered trademark of QUALCOMM Incorporated.

Copyright

©2009 Sprint. Sprint and the logo are trademarks of Sprint. Other marks are the property of their respective owners.

Limitation of Liability

The information in this manual is subject to change without notice and does not represent a commitment on the part of Sierra Wireless. SIERRA WIRELESS AND ITS AFFILIATES SPECIFICALLY DISCLAIM LIABILITY FOR ANY AND ALL DIRECT, INDIRECT, SPECIAL, GENERAL, INCIDENTAL, CONSEQUENTIAL, PUNITIVE OR EXEMPLARY DAMAGES INCLUDING, BUT NOT LIMITED TO, LOSS OF PROFITS OR REVENUE OR ANTICIPATED PROFITS OR REVENUE ARISING OUT OF THE USE OR INABILITY TO USE ANY SIERRA WIRELESS PRODUCT, EVEN IF SIERRA WIRELESS AND/OR ITS AFFILIATES HAS BEEN ADVISED OF THE POSSIBILITY OF SUCH DAMAGES OR THEY ARE FORESEEABLE OR FOR CLAIMS BY ANY THIRD PARTY.

Notwithstanding the foregoing, in no event shall Sierra Wireless and/or its affiliates aggregate liability arising under or in connection with the Sierra Wireless product, regardless of the number of events, occurrences, or claims giving rise to liability, be in excess of the price paid by the purchaser for the Sierra Wireless product.

Additional Information and Updates

For up-to-date product descriptions, documentation, application notes, firmware upgrades, troubleshooting tips, and press releases, visit www.sierrawireless.com.

Important Safety Information

- ◆ *Important Notice (page 35)*
- ◆ *Safety and Hazards (page 35)*

Important Notice

Because of the nature of wireless communications, transmission and reception of data can never be guaranteed. Data may be delayed, corrupted (i.e., have errors) or be totally lost. Although significant delays or losses of data are rare when wireless devices such as the AirCard 402 device are used in a normal manner with a well-constructed network, they should not be used in situations where failure to transmit or receive data could result in damage of any kind to the user or any other party, including but not limited to personal injury, death, or loss of property. SPRINT SPECTRUM L.P. accepts no responsibility for damages of any kind resulting from delays or errors in data transmitted or received using the AirCard 402 device, or for failure of the AirCard 402 device to transmit or receive such data.

Safety and Hazards

Do not operate the AirCard 402 device in areas where blasting is in progress, where explosive atmospheres may be present, near medical equipment, life support equipment, or any equipment which may be susceptible to any form of radio interference. In such areas, the AirCard 402 device **MUST BE POWERED OFF**. It can transmit signals that could interfere with this equipment.

Do not operate the AirCard 402 device in any aircraft, whether the aircraft is on the ground or in flight. In aircraft, the AirCard 402 device **MUST BE POWERED OFF**. When operating, it can transmit signals that could interfere with various onboard systems.

The driver or operator of any vehicle should not operate the AirCard 402 device while in control of a vehicle. Doing so will detract from the driver or operator's control and operation of that vehicle. In some jurisdictions, operating such communications devices while in control of a vehicle is an offense.

One-Year Limited Warranty

THIS PRODUCT IS PROVIDED TO YOU UNDER THE FOLLOWING TERMS AND CONDITIONS THAT CONTAIN LIMITATIONS ON WARRANTIES AND LIABILITIES AND YOUR REMEDIES. BY USING THIS PRODUCT YOU AGREE TO THE TERMS AND CONDITIONS BELOW.

The original end-user purchaser of the enclosed wireless personal computer modem card (the “**Product**”) from Sierra Wireless (the “**Vendor**”) or one of its authorized suppliers, is offered a personal, non-transferable, limited warranty that: (a) the Product will be of good quality and free from defects in design, materials, workmanship, and manufacture under normal use and service; (b) all materials, parts, components, and other items incorporated in the Product will be new; and (c) the Product will be compliant with, and perform in accordance with, its specifications, for a period that expires one year from the original purchase date of the Product (the “**Warranty Period**”).

During the Warranty Period, if Vendor determines that a Product is defective under a proper warranty claim, then Vendor will, at its sole discretion, either (a) pay parts and labor charges for the repair of the Product, or (b) replace the Product with a new or rebuilt unit (which unit may use refurbished parts of similar quality and functionality), provided that the defective Product is returned to a Vendor-authorized service center for the Product, transportation charges prepaid, and is accompanied by written proof of purchase in the form of a bill of sale or receipted invoice indicating that the Product was purchased by you and is within the Warranty Period. After the Warranty Period, you are responsible for paying all parts, labor, and shipping charges.

The warranty described above shall apply to all repaired or replaced Product for a period of 90 days from the date of return to you, or the balance of the Warranty Period, whichever is greater.

This limited warranty does not cover and is void with respect to: (a) Products which have been improperly installed, repaired, maintained, or modified; (b) Products which have

been subjected to misuse (including using the Products with hardware which is electrically or mechanically incompatible with the Products), abuse, accident, physical damage, abnormal operation, improper handling or storage, neglect, exposure to fire, water, or excessive moisture or dampness, or extreme changes in climate or temperature; (c) Products which have been opened, repaired, modified, or altered by anyone other than Vendor or a Vendor-authorized service center; (d) Products which have been damaged due to fire, flood, acts of God, or other acts which are not Vendor's fault and which the Product is not specified to tolerate; (e) cosmetic damage; (f) Products which have been operated outside of published maximum ratings; (g) cost of installation, removal, or reinstallation of the Product; (h) signal reception problems (unless caused by a defect in material(s) or workmanship); or (i) Products on which warranty stickers or serial numbers have been removed, altered, or rendered illegible.

This limited warranty is not transferable to any third party including, but not limited to, any subsequent purchaser or owner of the Products. Any transfer or resale of any of the Products will automatically terminate Vendor's warranty coverage of such Products.

This limited warranty is only valid in the United States of America, and does not cover customer education, instruction, installation, setup adjustments, or signal reception problems.

REPAIR OR REPLACEMENT, AS PROVIDED FOR UNDER THIS LIMITED WARRANTY, IS YOUR SOLE AND EXCLUSIVE REMEDY FOR BREACH OF THIS LIMITED WARRANTY. TO THE EXTENT PERMITTED BY APPLICABLE LAW, NEITHER VENDOR NOR THE ORIGINAL OWNER OF THE PRODUCT MAKE ANY OTHER REPRESENTATIONS, WARRANTIES, OR CONDITIONS OF ANY KIND, EXPRESS OR IMPLIED OR STATUTORY, WITH RESPECT TO THE PRODUCT INCLUDING, BUT NOT LIMITED TO, ANY WARRANTY OF MERCHANTABILITY, QUALITY, OR FITNESS FOR A PARTICULAR PURPOSE. This warranty gives you specific rights and you may also have other rights, which vary from jurisdiction to jurisdiction. Some jurisdictions do not allow the exclusion of implied warranties and conditions and do not permit the exclusion or limitation of certain damages. Therefore, the foregoing exclusions may not apply to you.

THE ENTIRE RISK AS TO THE RESULTS AND PERFORMANCE OF THIS PRODUCT IS ASSUMED BY YOU. NEITHER THE ORIGINAL OWNER OF THE PRODUCT NOR THE VENDOR NOR VENDOR'S DISTRIBUTORS, RESELLERS, SUPPLIERS, AGENTS, OFFICERS, AND DIRECTORS SHALL HAVE ANY LIABILITY TO YOU OR TO ANY OTHER PERSON OR ENTITY FOR ANY DAMAGES HOWSOEVER CAUSED INCLUDING, BUT NOT LIMITED TO, DIRECT, INDIRECT, INCIDENTAL, SPECIAL, GENERAL, CONSEQUENTIAL, PUNITIVE, OR EXEMPLARY DAMAGES WHATSOEVER INCLUDING, BUT NOT LIMITED TO, LOSS OF REVENUE OR PROFIT, DAMAGES TO PROPERTY OR PERSONS, LOST OR DAMAGED DATA, OR OTHER COMMERCIAL OR ECONOMIC LOSS, EVEN IF ANY SUCH AFOREMENTIONED PERSON HAS BEEN ADVISED OF THE POSSIBILITY OF SUCH DAMAGES OR THEY ARE FORESEEABLE, OR FOR CLAIMS BY ANY THIRD PARTY. MAXIMUM AGGREGATE LIABILITY OF THE AFOREMENTIONED PERSONS SHALL NOT EXCEED THE AMOUNT PAID BY YOU FOR THE PRODUCT. THE LIMITATIONS IN THIS SECTION SHALL APPLY WHETHER OR NOT THE ALLEGED BREACH, DEFAULT, NON-PERFORMANCE, OR FAILURE IS A BREACH OF FUNDAMENTAL CONDITION OR TERM, OR A FUNDAMENTAL BREACH.

In the event that the Product supplied by Vendor is found to infringe any third-party US or Canadian patent, trade secret, copyright, trademark, or other proprietary right and/or the use of the Product is enjoined, Vendor will, at its sole option, either (a) procure for you the right to use such Product; (b) modify such Product so that it becomes non-infringing while giving equivalent functionality and performance; or (c) if neither of the foregoing options is reasonably available, refund to you all amounts paid for the infringing Products, depreciated on a straight line basis over a three-year period. Vendor will have no liability or obligation to you to the extent the infringement is caused by, or based upon: (a) use of the Product in an application or environment, or on a platform, or with devices for which the Product was not designed or contemplated; (b) modifications, alterations, combinations, or enhancements of the Product not created by Vendor; (c) any third-party defined feature that Vendor incorporates into the Product at the request of such third party; or (e) your failure to install any corrections or enhancements made available by Vendor that maintain equivalent or better functionality and performance, to the extent that such correction or enhancement would have avoided the infringement claim. Vendor's obligations do not apply to any alleged infringement occurring after you have received written notice of the

alleged infringement. THE FOREGOING IS IN LIEU OF ANY REPRESENTATIONS, WARRANTIES, OR CONDITIONS OF NON-INFRINGEMENT, WHICH ARE HEREBY DISCLAIMED, AND SETS FORTH THE ENTIRE LIABILITY OF VENDOR AND THE ORIGINAL OWNER OF THE PRODUCT FOR ANY INFRINGEMENT OF ANY INTELLECTUAL PROPERTY RIGHTS BY THE PRODUCT.

If any provision or term of these terms and conditions is determined to be invalid or unenforceable, the invalidity or unenforceability of that provision or term will not affect the validity or enforceability of the remaining provisions and terms or the validity or enforceability of that provision or term in any other jurisdiction.

